

Pressure switches
Pressostats
Druckwaechter
Presostatos
Pressostati
Pressostatos

MXM

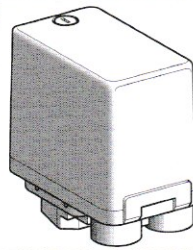

XMA

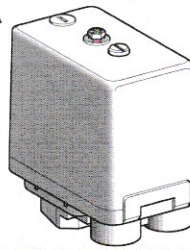

XMP

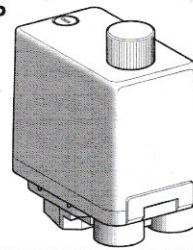

⚠ DANGER / DANGER / GEFAHR / PELIGRO / PERICOLO / PERIGO

HAZARD OF ELECTRIC SHOCK, EXPLOSION, OR ARC FLASH

- Disconnect all power before servicing equipment.
- Reduce pressure to zero and take the appropriate protective measures in regard of measured fluid before disconnecting device from pressure source.

Failure to follow these instructions will result in death or serious injury.

RIESGO DE ELECTROCUCIÓN, EXPLOSIÓN O ARCO ELÉCTRICO

- Desconecte toda alimentación antes de realizar el servicio.
- Reduzca la presión a cero y tome las medidas de protección correspondientes con relación al fluido medido antes de desconectar el dispositivo de la fuente de presión.

Si no se siguen estas instrucciones provocará lesiones graves o incluso la muerte.

RISQUE D'ELECTROCUTION, D'EXPLOSION OU D'ARC ELECTRIQUE

- Couper l'alimentation avant de travailler sur cet appareil.
- Réduisez la pression à zéro et prenez les mesures de protection appropriées concernant le fluide mesuré avant de déconnecter l'appareil de la source de pression.

Le non-respect de ces instructions provoquera la mort ou des blessures graves.

RISCHIO DI SCOSSA ELETTRICA, DI ESPLOSIONE O DI OTTALMIA DA FLASH

- Scollegare l'apparecchio dalla presa di corrente prima di qualsiasi intervento.
- Ridurre la pressione a zero e prendere le misure appropriate di protezione per quanto riguarda il fluido misurato prima di scollegare il dispositivo dalla sorgente di pressione.

Il mancato rispetto di queste istruzioni provocherà morte o gravi infortuni.

STROMSCHLAG-, EXPLOSIONS- ODER LICHTBOGENGEFAHR

- Vor dem Arbeiten an dem Gerät dessen Stromversorgung abschalten.
- Reduzieren Sie den Druck auf Null und ergreifen Sie angemessene Sicherheitsmaßnahmen hinsichtlich des gemessenen Mediums, bevor Sie das Gerät von der Druckquelle trennen.

Die Nichtbeachtung dieser Anweisungen führt zu Tod oder schwerer Körperverletzung.

RISCO DE CHOQUE ELÉCTRICO, EXPLOÇÃO OU FAISCA

- Scollegare l'apparecchio dalla presa di corrente prima di qualsiasi intervento.
- Reduza a pressão a zero e tome as medidas de protecção adequadas no que se refere ao líquido medido antes de desligar o dispositivo da fonte de pressão.

A não observância destas instruções resultará em morte, ou ferimentos graves.

Dimensions - Encombrements - Abmessungen - Dimensiones - Dimensioni - Atravancamentos

1mm = 0.0394in.

MXM/XMP-A06•21••/A12•21••

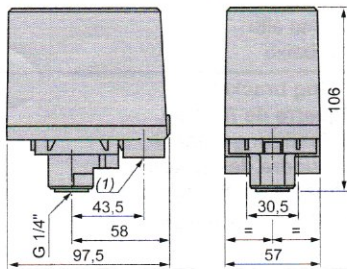

MXM/XMP-A06•24••/A12•24••

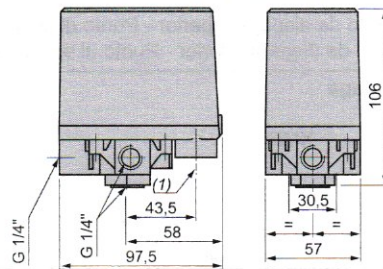

MXM/XMP-A25•21••

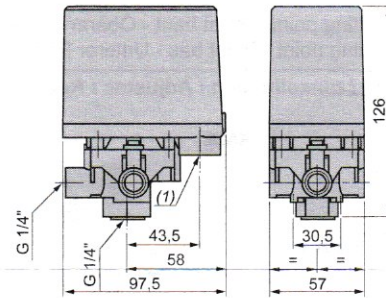

XMA-•06•21••/XMA-•12•21••

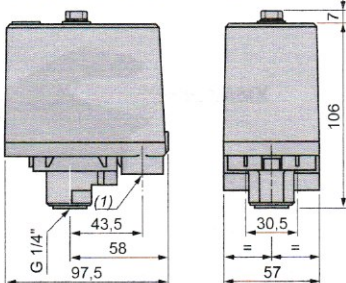

XMA-•06•24••/XMA-•12•24••

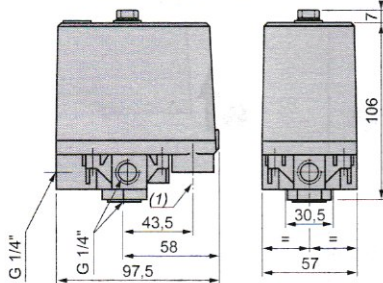

XMA-•25•21••

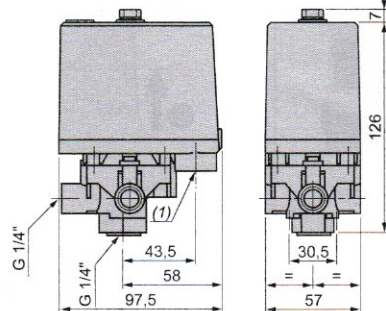

XMP-D/E06/12•••••

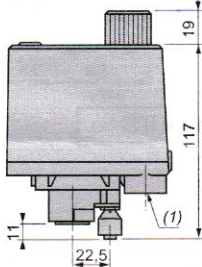

XMP-R06/12•••••

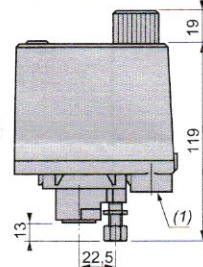

XMP-R25•••••

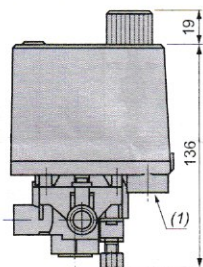

XMP-B/C•••••

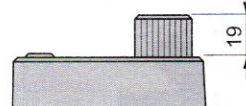

MXM/XMAXMP

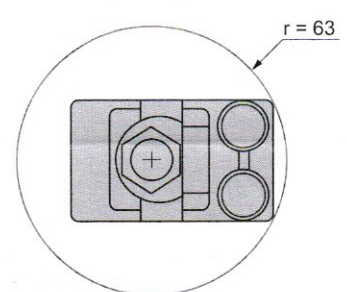

(1): 2 tapped holes for cable gland 13. / 2 trous taraudés pour presse-étoupe 13. / 2 Gewindebohrungen für Kabelstutzen 13. / 2 orificios perforados para casquillo para paso de cables 13. / 2 fori filettati per passacavo da 13. / 2 orificios perforados por glante de cabo 13.

- EN** Electrical equipment should be installed, operated, serviced, and maintained only by qualified personnel. No responsibility is assumed by Schneider Electric for any consequences arising out of the use of this material.
- FR** Les équipements électriques doivent être installés, exploités et entretenus par un personnel qualifié. Schneider Electric décline toute responsabilité quant aux conséquences de l'utilisation de ce matériel.
- DE** Elektrische Geräte dürfen nur von Fachpersonal installiert, betrieben, gewartet und instand gesetzt werden. Schneider Electric haftet nicht für Schäden, die aufgrund der Verwendung dieses Materials entstehen.

- ES** Sólo el personal de servicio cualificado podrá instalar, utilizar, reparar y mantener el equipo eléctrico. Schneider Electric no asume las responsabilidades que pudieran surgir como consecuencia de la utilización de este material.
- IT** Le apparecchiature elettriche devono essere installate, usate e riparate solo da personale qualificato. Schneider Electric non assume nessuna responsabilità per qualunque conseguenza derivante dall'uso di questo materiale.
- PT** O equipamento eléctrico só deve ser instalado, utilizado e reparado por técnicos especializados. A Schneider Electric não assume qualquer responsabilidade por quaisquer consequências decorrentes da utilização deste material.

© 2016 Schneider Electric. "All Rights Reserved."

XM●●06

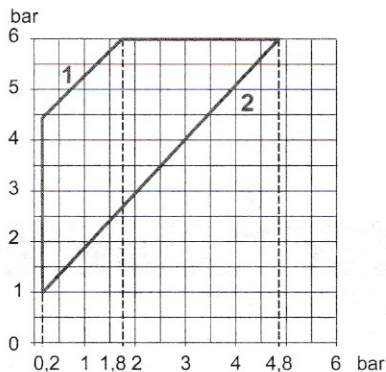

XM●●12

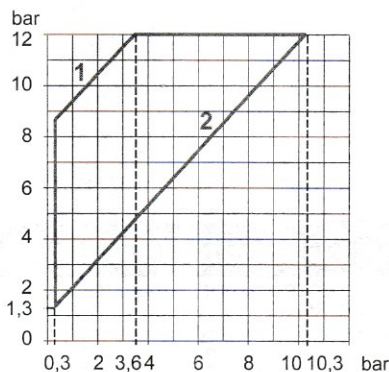

XM●●25

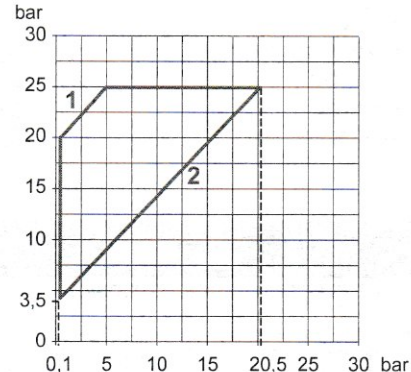

1 : Maximum differential - Ecart maxiaux - Maximale hysteresen - Intervalos máximos - Differenziali max - intervalos maximos
 2 : Minimum differential - Ecart miniaux - Minimale hysteresen - Intervalos mínimos - Differenziali min - intervalos minimos

MXM/XMA

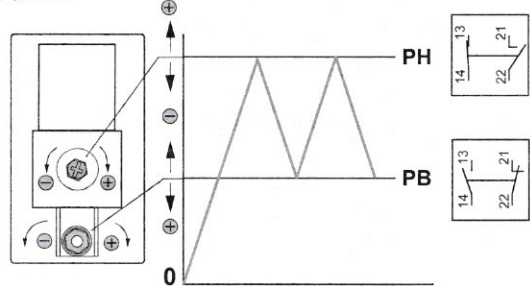

XMP

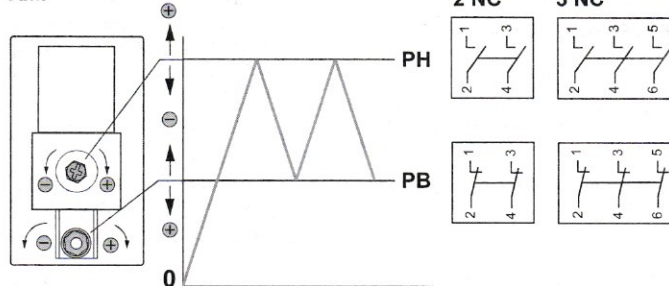

PH : High setting point - Point haut - Oberer Schaltungspunkt - Punto de disparo superior - Punto di scatto superiore - Ponto alto
 PB : Low setting point - Point bas - Unterer Schaltungspunkt - Punto de disparo inferior - Punto di scatto inferiore - Ponto baixo

Setting / Réglage / Einstellungen / Adjustes / Regolazione / Reglage

XMA

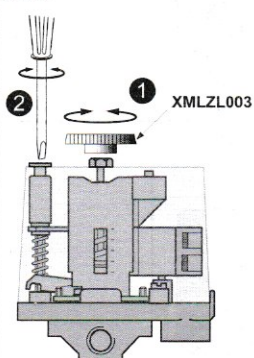

MXM

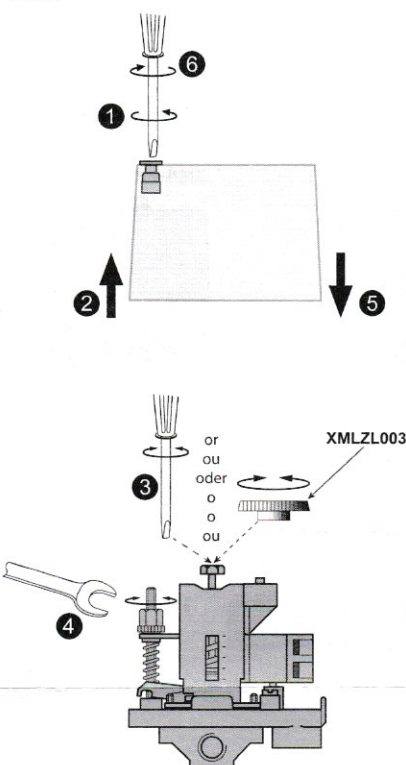

XMP

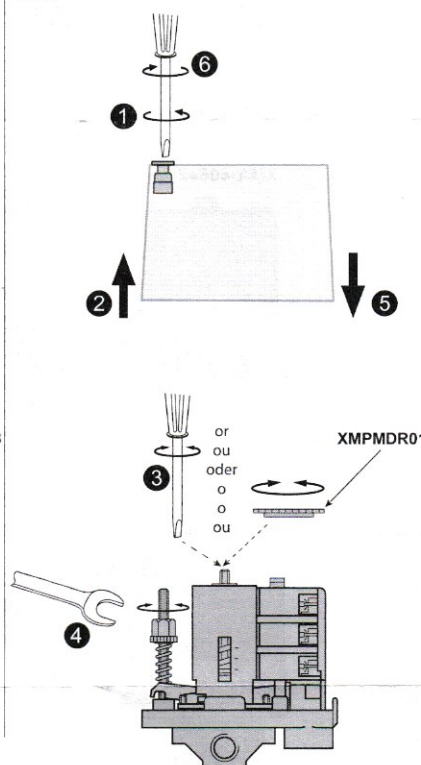

Fixing bracket
 Equerre de fixation
 Befestigungswinkel
 Escuadra de fijación
 Squadra de fissaggio
 Esquadro de fixaçã

XMAZL001

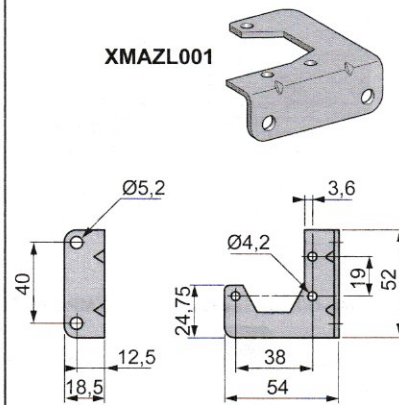

1mm = 0.0394in.

CAUTION / ATTENTION / VORSICHT / AVISO / ATTENZIONE / ATENÇÃO

Equipment damaged

Use the equipment within the characteristics mentioned in catalogue

Failure to follow these instructions can result equipment damage.

Equipo dañado

Utilice el equipo dentro de los límites de las características que se mencionan en el catálogo

Si no se siguen estas instrucciones pueden producirse daños en el equipo.

Equipement endommagé

Utilisez l'équipement en respectant les caractéristiques mentionnées dans le catalogue.

Le non-respect de ces instructions peut provoquer des dommages matériels.

Apparechiatura danneggiata

Utilizzare l'apparechiatura secondo le caratteristiche citate nel catalogo

Il mancato rispetto di queste istruzioni può danni alle apparecchiature.

Gerät beschädigt

Verwenden Sie das Gerät innerhalb der im Katalog aufgeführten Kenndaten

Die Nichtbeachtung dieser Anweisungen kann zu Materialschäden führen.

Equipamento danificado

Utilize o equipamento dentro das especificações mencionadas no catálogo

A não observância destas instruções pode danos no equipamento.